

Cut Sheet - PD300F

1. Installation to be completed in accordance with manufacturer's written specifications and installation instructions.
2. See spec sheet or contact manufacturer for detailed material, finishes, and configuration options.
3. Contact manufacturer for detailed layout.
4. Do not scale drawings.
5. Subject to change without notice.
6. Aluminum half-round pad-style snow guards will have a third button connecting the pad to the strap.
7. For patent information, visit our [Patent Page](#).

Available Materials

- Aluminum
- Copper
- Lead-Coated Copper

Available Finishes

- Mill Finish (Standard)
- Powder Coated
(Tiger Drylac RAL# _____)

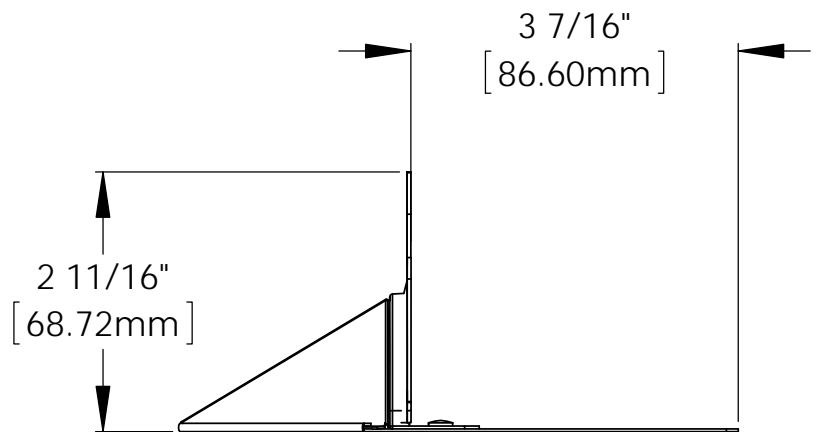
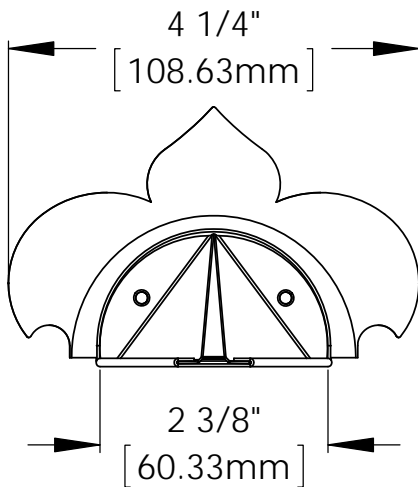
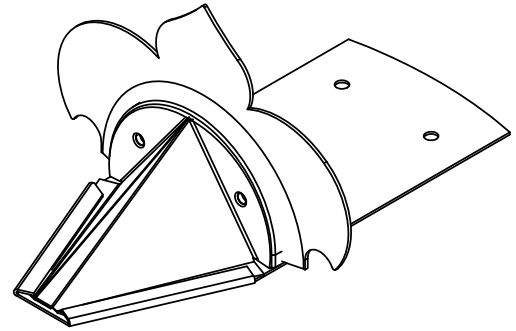
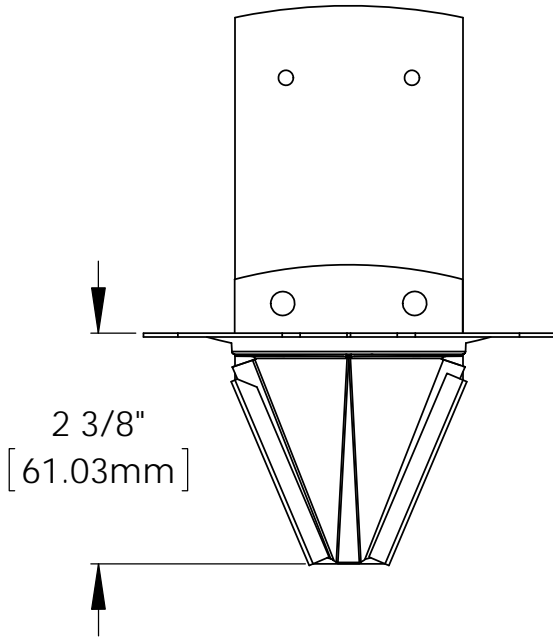

289 Harrel Street
Morrisville, VT 05661
Phone: 1.888.766.4273
Fax: 1.888.766.9994
Email: Info@alpinesnowguards.com

Scale: 1:2

8/1/2020