

# Cut Sheet - PD100F

1. Installation to be completed in accordance with manufacturer's written specifications and installation instructions.
2. See spec sheet or contact manufacturer for detailed material, finishes, and configuration options.
3. Contact manufacturer for detailed layout.
4. Do not scale drawings.
5. Subject to change without notice.

## Available Materials

- Aluminum
- Copper
- Lead-Coated Copper

## Available Finishes

- Mill Finish (Standard)
- Powder Coated  
(Tiger Drylac RAL# \_\_\_\_\_)

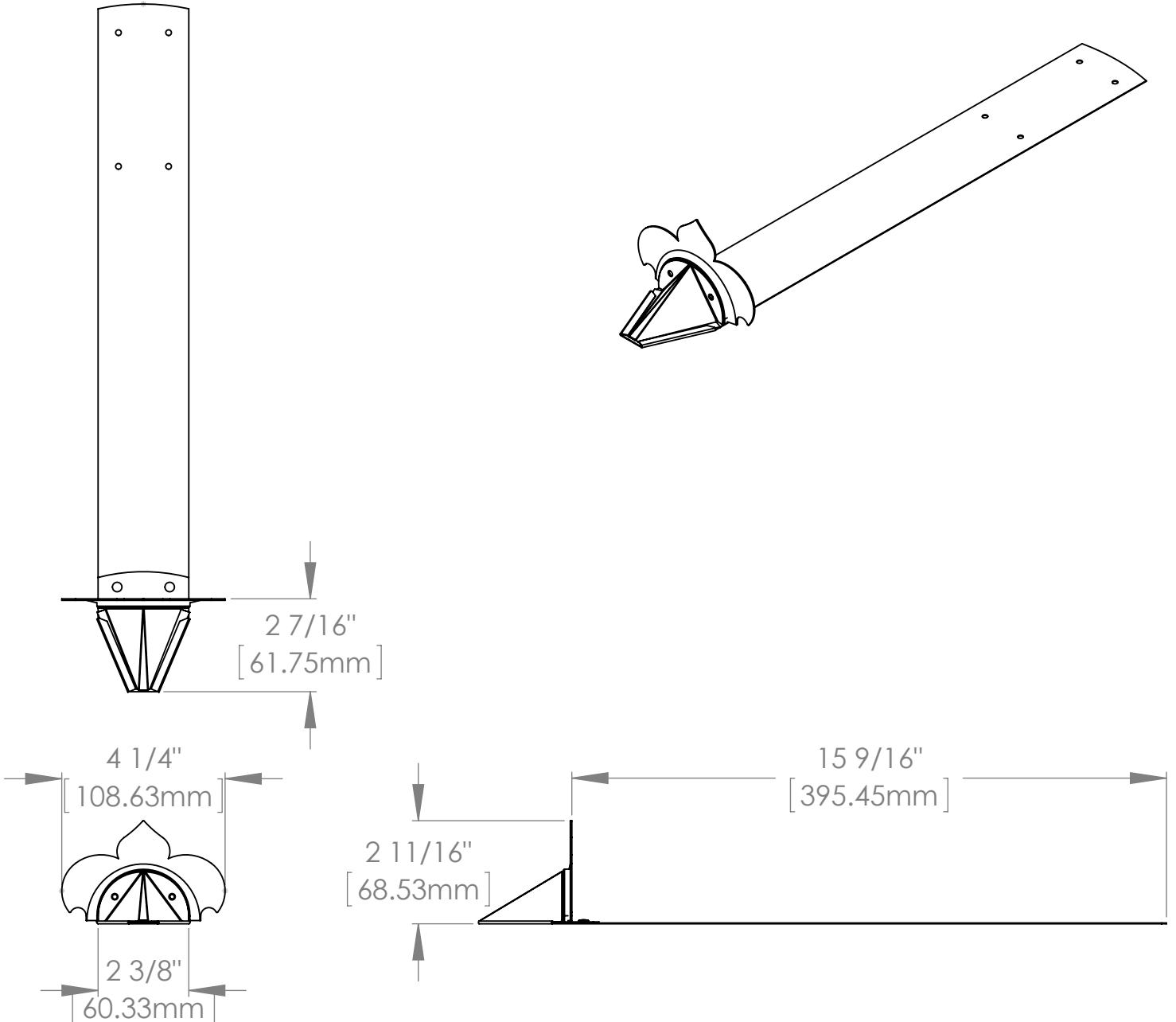

289 Harrel Street  
Morrisville, VT 05661  
Phone: 1.888.766.4273  
Fax: 1.888.766.9994  
Email: [Info@alpinesnowguards.com](mailto:Info@alpinesnowguards.com)

Scale: 1:4

4/25/2018