



## General Installation Instructions for Pipe-Style Snow Guard Accessories

All of our pipe-style snow guard accessories fit all of our pipe snow guards for through fastened or clamp to seam applications. Our #2000 cannot use Ice Flags or Ice Screen; these require at least two pipes. Accessories are available in aluminum or brass, the aluminum accessories can be powder coated. Internal couplings are not painted or powder coated. Ice Screen is available in stainless steel only.

### End Collars (#65)

The purpose of the End Collar is to keep the pipes from sliding through the snow guard brackets. An End Collar is required for each end of each pipe on each run of snow guards. A run should not exceed 100' to allow for heat expansion...

1. End Collars (#65) should be placed over each end of each run of pipe (Figure 1). Place the End Collar over the pipe and tighten the set screw until it no longer slides. The End Collar should be within 1" of the snow guard bracket, spacing is 1/8" for every 10' of pipe. For example, if the run of snow guards is 80' then the End Collar should be 1" outside the bracket.

Note: on some three-pipe or hi-hole systems it may be necessary to place one End Collar inside the bracket and the others outside (Figure 2).

### End Caps (#56)

End Caps keep moisture and insects from getting inside of the pipes.

1. Install the End Cap by pressing it into the end of the pipe.

### Ice Flags (#95)

Ice Flags hang from the pipe between the brackets to help keep ice and snow from sliding underneath.

1. The Ice Flags should be placed over the second pipe – top pipe in two-pipe systems or middle pipe in three-pipe systems. The long leg rests against the uphill side of the pipes. Use the carriage bolt and nut to hold the flag in position. Apply silicone based sealant or adhesive between the Ice Flag and the pipe to keep the flag from sliding.

### Internal Coupling (#86)

The Internal Couplings are used to join pipes together.

1. Insert assembled coupling into the end of one pipe so that half of the solid aluminum shaft is inserted (Figure 5).
2. Begin twisting the exposed half of the coupling in a clockwise motion until the rubber gasket engages the pipe. Continue to tighten until the coupling cannot be easily pulled out of the pipe (Figure 6).

Figure 1.

End  
Collars

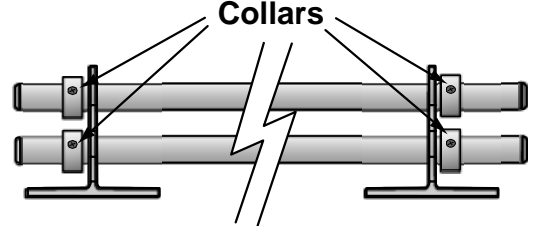

Figure 2.

End  
Collars

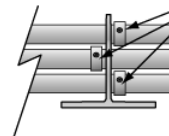

Figure 3.

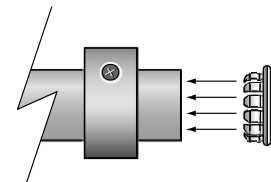

Figure 4.

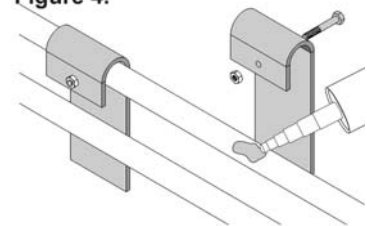

Figure 5.

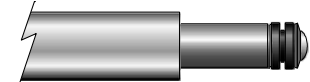
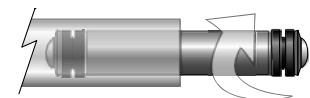

Figure 6.



## Alpine SnowGuards Pipe Accessories Installation Instructions



- Slide the next section of pipe over the exposed half of the coupling. Twist the tube in a clockwise motion until the rubber gasket engages the pipe. Continue tightening until the tubing cannot be easily pulled apart (Figure 7).
- If the system needs to be unassembled, simply turn the pipe counter-clockwise until the pipes can be pulled apart.

Internal Couplings come assembled and ready for installation. If they come apart or loosened during shipment assemble per the detail. **Do Not Over Tighten** prior to inserting the coupling into the #75 pipe. Over tightening the bolt will cause the gasket to expand and make installation of the coupling difficult.

### Ice Screen (#98)

Ice Screen comes in 4' lengths, 5" high; for most installations it will need to be cut to size to fit between the snow guard brackets.

- Place the Ice Screen behind (upslope) the installed pipes.
- Place a U-bolt on the pipe and fit it through the openings in the Ice Screen.
- Place the backing plate behind the Ice Screen and insert the ends of the U-bolt through the slotted openings.
- Tighten the supplied locking nuts.

Each length of Ice Screen includes 3 U-bolts, 3 slotted back plates and 6 locking nuts. Ice screen should be attached behind the bottom two pipes in a three-pipe installation or on both pipes of a two-pipe installation.

Figure 7.

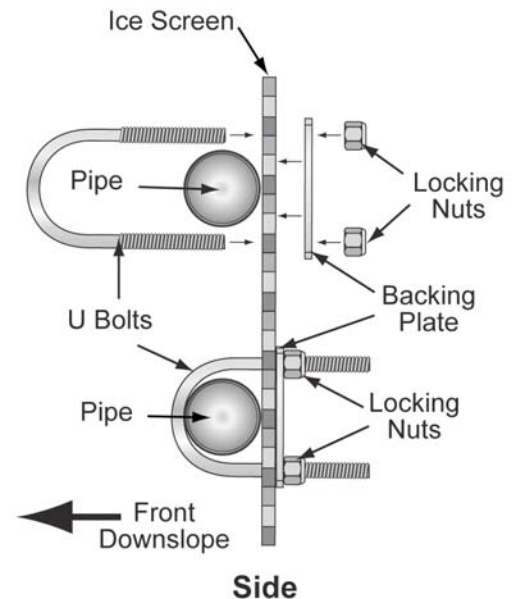
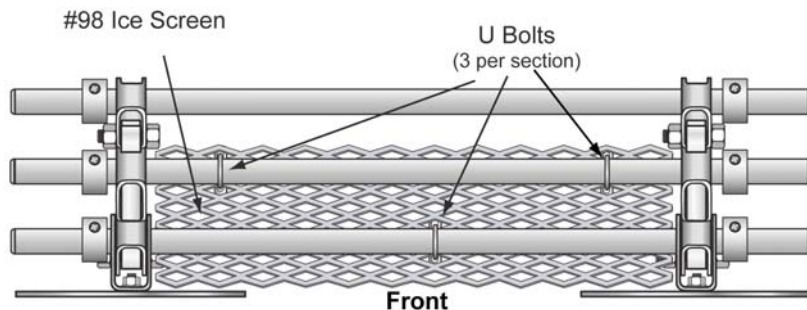
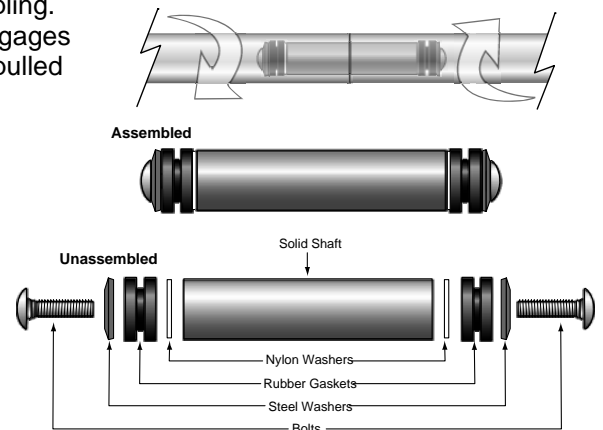

### Typical Installation

The illustration to the right shows a #225 with End Caps, End Collars, Internal Couplings & Ice Flags installed.

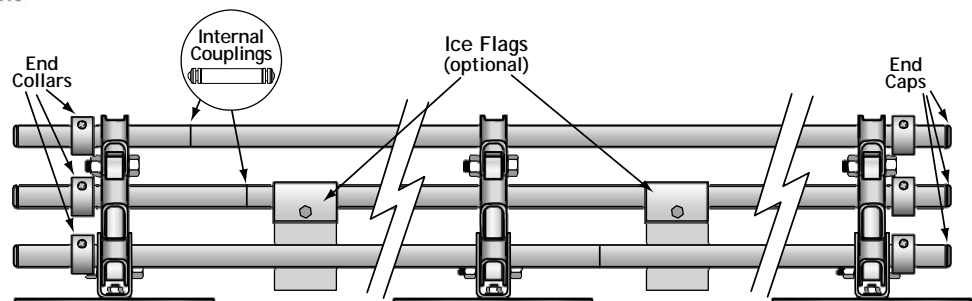

## Alpine SnowGuards Pipe Accessories Installation Instructions